

ONETRACK DALI[®]



- 7-Leiter Einbauschiene für drei Stromkreise plus Datenbus
- Bestehend aus einem stranggepressten Aluminiumprofil mit je zwei eingebetteten Kupferleitern, drei getrennt schaltbaren Stromkreisen, Schutzleiter über das Aluminiumprofil plus zwei Datenleiter.
- Eine bauseitige Längenanpassung kann problemlos durch einfaches Sägen vorgenommen werden. Ein Rückschneidewerkzeug ist notwendig.
- Die Profilgeometrie erlaubt ein einfaches und flexibles Abhängen mittels Federclip
- Die Einbindung in Gebäudemanagementsysteme ist möglich.
- Die Dateninformationen können entlang der Stromschiene an beliebiger Stelle mit den Busadaptoren abgegriffen werden. Neben dem DALI Protokoll kann der Datenbus auch für DMX, 0-10V oder KNX Protokolle genutzt werden. Adaptern ohne Datenbusabgriff können über den normalen Phasenabgriff ebenfalls in die Schiene mit Datenbus eingesetzt werden. In diesem Fall ist eine Datenbus-Funktionalität nicht verfügbar.

Farben für Stromschiene (standardmäßig beschichtet), Systemteile und Adaptern

- Weiß
- Schwarz
- Silber (Schiene)
- Grau (Zubehör)

- Zubehör ab Seite 60
- Planungsschema Seite 60

- 7-wire recessed track for three circuits plus data bus
- Made of an extruded aluminum profile with two embedded copper conductors each, three separately switchable circuits, protective conductor via the aluminum profile plus two data conductors.
- A length adjustment by the customer can easily be made by simple sawing. A cutting tool is required.
- The profile geometry allows simple and flexible suspension by spring clip.
- Integration into building management systems is possible. The data information can be tapped at any point along the track using the bus adaptors. In addition to the DALI protocol, the data bus can also be used for DMX, 0-10V or KNX protocols. Adaptors without data bus can also be used in the track with data bus via the normal phase. In this case, data bus functionality is not available.

Colours for power tracks (standard coated), system components and adaptors

- White
- Black
- Silver (power tracks)
- Grey (Accessories)

- Accessories see page 60
- Planning scheme see page 60

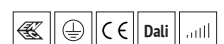

ONETRACK DALI
Stromschiene | Power-track

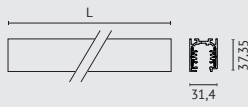

	L.1000 mm	L.2000 mm	L.3000 mm	L.4000 mm
	575-101	575-201	575-301	575-401
	575-102	575-202	575-302	575-402
	575-107*	575-207*	575-307*	575-407*

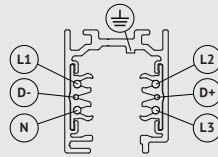

*Silber eloxiert



Rückschneidewerkzeug, verzinkter Stahl mit Griffisolierung
Cutting Tool, galvanized steel with handle isolation

575099010

Erforderlich zum Kürzen der Kupferleiter.
Required to shorten the copper conductors.

Zubehör | Accessories



Endkappe
End-cap

	575012171
	575012172
	575012178

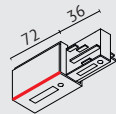

Einspeiser
End-feed

	575212011
	575212012
	575212018

Schutzleiter rechts
Ground right

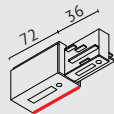

Einspeiser
End-feed

	575212021
	575212022
	575212028

Schutzleiter links
Ground left

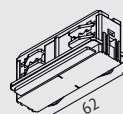

Längsverbinder innenliegend
Straight connector inside

	575212061
	575212062
	575212068

Bei Seil- und Pendelaufhängung aus statischen Gründen Stoßstellenverbinder separat bestellen.
To join two sections of track electrically. For static reasons order mechanical coupler if suspended via pendant rod or wire.

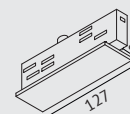

Mitteneinspeiser
Mid-feed

	575252031
	575252032

Für bauseitige Profilbohrung. An beliebiger Stelle ohne Teilung der Stromschiene positionierbar.
For on-site profile drilling. To be placed anywhere along the track; track cutting not required.

Verbinder mit Einspeisemöglichkeit | Connector with feeding option

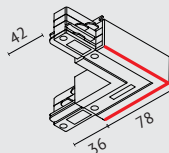

L-Verbinder | L-connector

	575212091
	575212092
	575212098

Schutzleiter außen
Ground outside

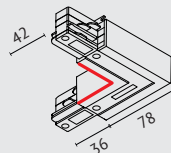

L-Verbinder | L-connector

	575212101
	575212102
	575212108

Schutzleiter innen
Ground inside

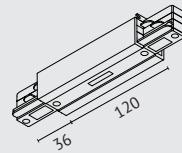

I-Verbinder | I-coupler

	575212081
	575212082
	575212088

Mit Einspeisemöglichkeit
With feeding option

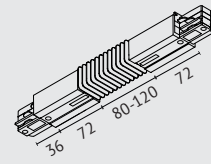

Flexverbinder | Flexible connector

	575212111
	575212112
	575212118

Biegeradius von 30° bis 330°
30° to 330° bending radius

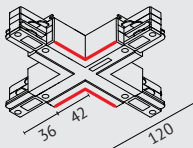

X-Verbinder | X-connector

	575212161
	575212162
	575212168

Mit Einspeisemöglichkeit
With feeding option

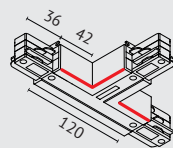

T-Verbinder | T-connector

	575212121
	575212122
	575212128

Schutzleiter innen, rechts
Ground inside, right

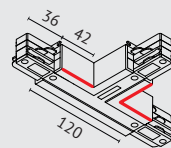

T-Verbinder | T-connector

	575212131
	575212132
	575212138

Schutzleiter innen, links
Ground inside, left

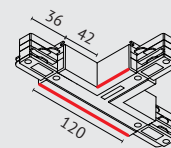

T-Verbinder | T-connector

	575212141
	575212142
	575212148

Schutzleiter außen, rechts
Ground outside, right

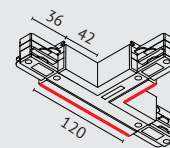

T-Verbinder | T-connector

	575212151
	575212152
	575212158

Schutzleiter außen, links
Ground outside, left

Farben | Colors

Weiß | White Schwarz | Black Grau | Grey

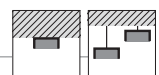

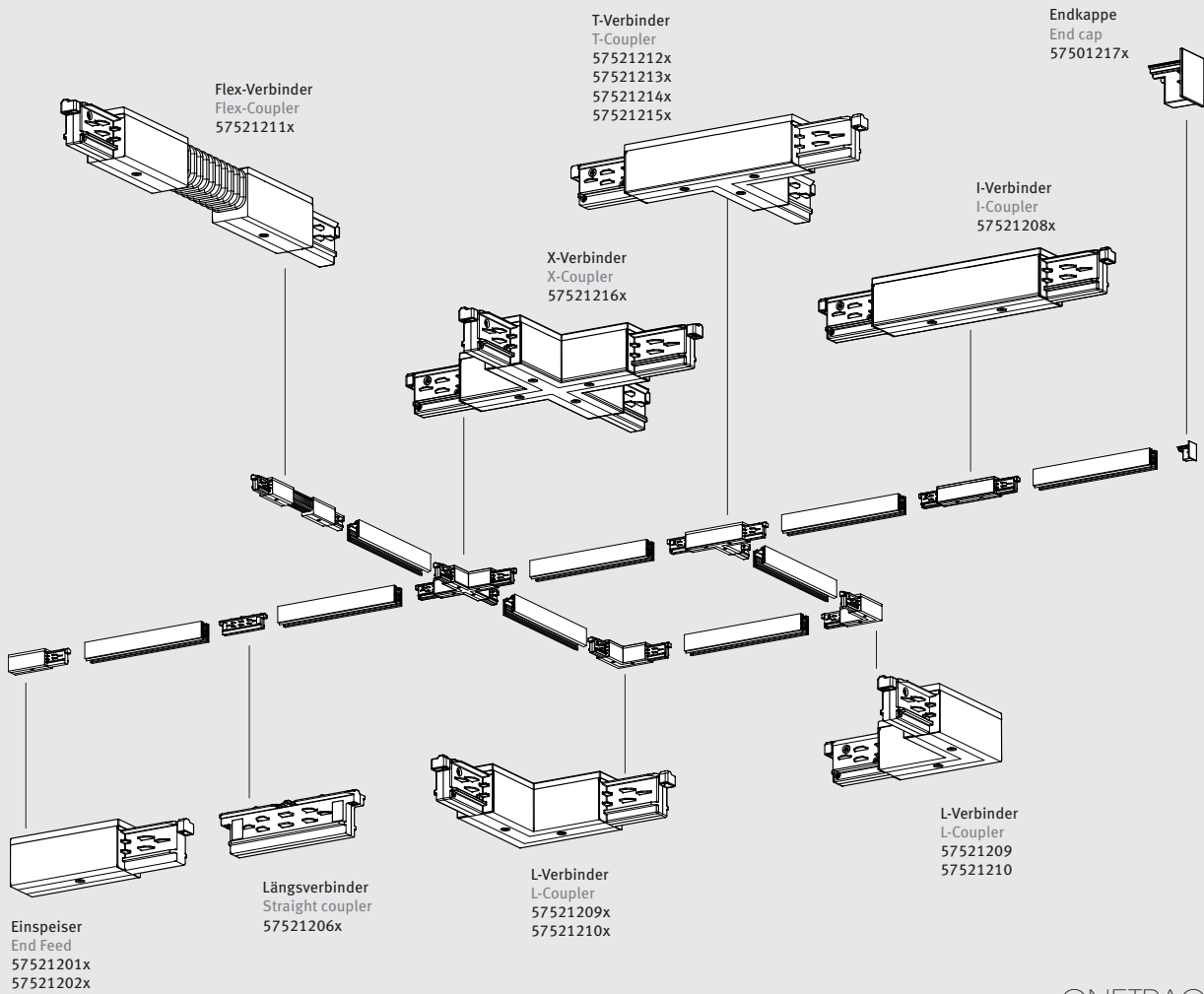

ONETRACK DALI



Multiadapter mit Datenbus
Multiadapter with data bus

- 575267101**
- 575267102**
- 575267108**



UniAdapter asymmetrisch mit Datenbus
UniAdapter asymmetrical with data bus

- 575267201**
- 575267202**
- 575267208**



LED Konverter In-Track Adapter
LED Converter In-Track Adapter
21W, 500mA, DALI

- 575263201**
- 575263202**



LED Konverter In-Track Adapter
LED Converter In-Track Adapter
30W 700mA, On/Off

- 575163201**
- 575163202**



In-Track Adapter
In-Track Adapter
DALI

- 575265331**
- 575265332**



In-Track Adapter
In-Track Adapter
ON/OFF

- 575165331**
- 575165332**



Abdeckung für 3~Aufbauschiene
Cover for 3~surface
L1000 mm

- 575014071**
- 575014072**
- 575014078**



Aufbau-Universal-Punktauslass für
3-Phasen-Adapter
3~ Surface-Universal Monopoint

- 575072281**
- 575072282**
- 575072288**



Einbautopf für Universal-Punktauslass
Recessed-Universal Monopoint

- 575072271**
- 575072272**
- 575072278**



Haken
Hook

- 575066171**
- 575066172**
- 575066178**



Montagenippel
Retaining collar (female)

- M10 **575006010**
- M13 **575006020**



Montagenippel Außengewinde
Retaining collar (male thread)

- M10 **575066030**
- M13 **575066040**



Montagenippel Innengewinde
Retaining collar (female)

- M10 **575066020**



Steckdosen-Multi-Adapter
Power-socket adapter

- SCH-0951N**
- SCH-0952**

Sicherung, 6,3A träge | With idle 6,3A time-lag fuse
Kompatibel zu ONETRACK | Compatible to ONETRACK

Farben | Colors

- Weiß | White
- Schwarz | Black
- Grau | Grey

Deckenbefestigungen | Ceiling clips

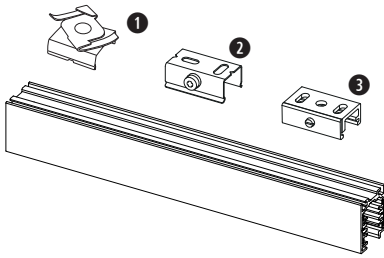

- 1**
Deckenclip für Rasterdecken
Clip for ceiling grid
- SCH-9817-1
 - SCH-9818-2
 - SCH-9802-7

- 2**
Pendelclip | Pendant clip
40 mm
- 575014010 (verzinkt)

- 3**
Pendelclip | Pendant clip
40 mm
- 575014041
 - 575014042
 - 575014040 (Aluminium)

Systemabhängungen | Suspensions

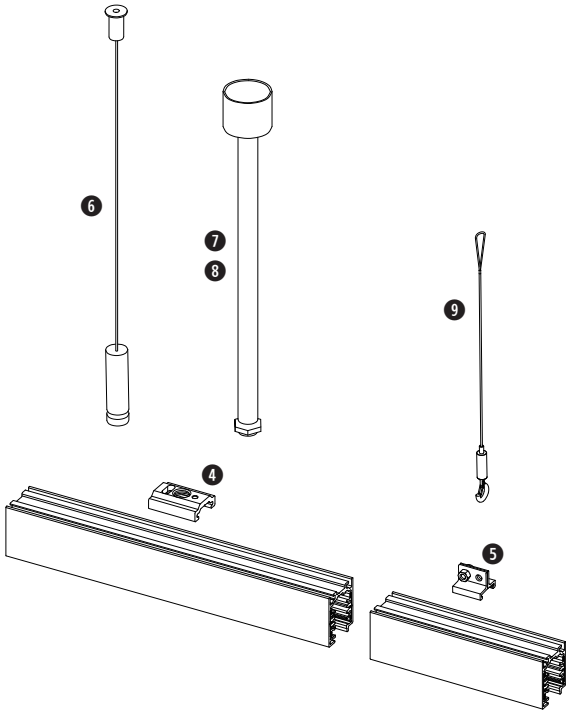

- 4**
Pendelclip
Pendant clip
35 mm
- 575014021
 - 575014022

- 5**
Halteclip für Haken / Schlaufen
Clip for hooks / loops
25 mm
- 575014051
 - 575014052
 - 575014050 (Aluminium)

- 6**
Seilabhängung, höhenverstellbar
Rope suspension, height adjustable
- L1500 mm SCH-3187
 - L3000 mm SCH-3197
 - L6200 mm SCH-6207

- 7**
Rohrpendelaufhängung L600 mm
Pendant rod L600 mm
- SCH-9051N
 - SCH-9052
 - SCH-9057

- 8**
Rohrpendelaufhängung L1200 mm
Pendant rod L1200 mm
- SCH-9061N
 - SCH-9062
 - SCH-9067



Zu verwenden mit Pendelclip oder Stoßstellenverbinder und Stromschienen Clip, höhenverstellbar, verzinkt
To be used with pendant clip or mechanical coupler and power track clip, height adjustable, galvanized

- 9**
Seilabhängung mit Schnellabhänger für Halteclip, höhenverstellbar, silber
Steel suspension wire with fast hanger, height adjustable, silver
L3000mm
- SCH-6790**

Stoßstellenverbinder | Mechanical couplers

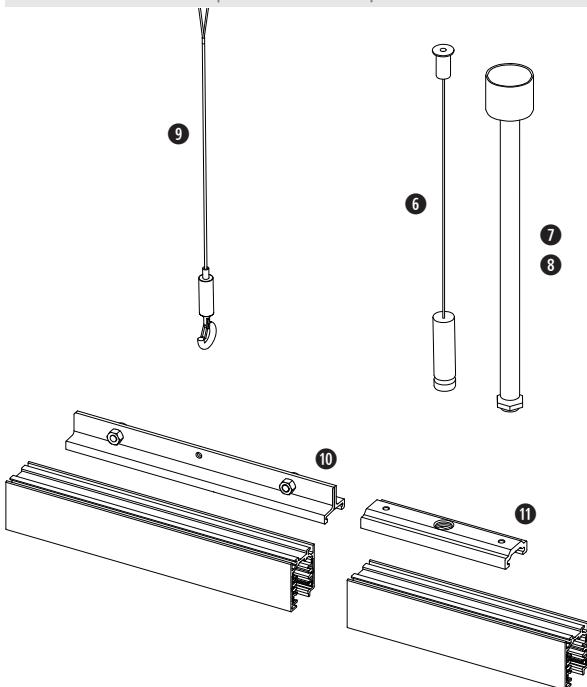

- 10**
Stoßstellenhalteclip 180 mm für Haken/Schlaufen
Mechanical coupler 180 mm for hooks / loops
- 575014061
 - 575014062
 - 575014060 (Aluminium)

- 11**
Stoßstellenverbinder 100 mm für Seil- u. Pendelabhängung für Ø 13mm
Mechanical coupler 100 mm for steel cable or pendant rod, for Ø 13mm
- 575014031
 - 575014032

Farben | Colors

□ Weiß | White ■ Schwarz | Black ■ Grau | Grey